



Technical Data

End Suction Pump - EAZS80/32-30004

Revision no.

Page:

1

Receiver

From

 Company name
 Respons. Department
 Person in charge
 Phone number
 Fax no
 E-mail address

Brand: Gol Pumps
Model: EAZS80/32-30004

Motor (B35)	
Model	hp
Y2-200L-4	40

Weight (lb)		
Pump	Motor	Pump & motor
236	529	765

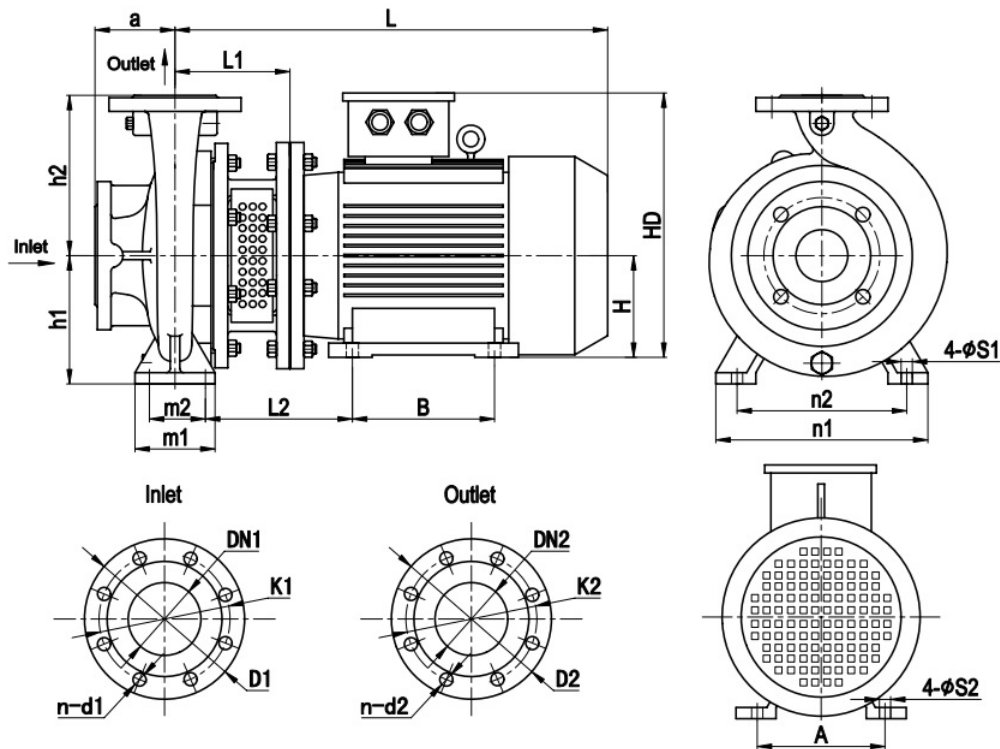
Dimensions:

ISO7005.2 DIN2501 PN16 GB/T17241.6 PN1.6									
DN1 / DN2	1.25	1.5	2	2.5	3	4	5	6	8
D1 / D2	5.51	5.91	6.50	7.28	7.87	8.66	9.84	11.22	13.39
K1 / K2	3.94	4.33	4.92	5.71	6.30	7.09	8.27	9.45	11.61
n-d1 / n-d2	4-Ø18	4-Ø18	4-Ø18	4-Ø18	8-Ø18	8-Ø18	8-Ø18	8-Ø22	12-Ø22

Inlet and outlet flange	
DN1	DN2
4	3

Pump installation size (inch)															
a	h1	h2	L1	L2	L	A	B	H	HD	m1	m2	n1	n2	S1	S2
4.92	9.84	12.40	9.33	12.20	35.31	12.52	12.01	7.87	19.88	6.30	4.72	15.75	12.40	0.71	0.75

Project

Project ID

Created by

Created on

Last update



Performance Curves

End Suction Pump - EAZS80/32-30004

Revision no. _____
 Page: 2

	Receiver	From
Company name		
Respons. Department		
Person in charge		
Phone number		
Fax no		
E-mail address		

Model	Capacity		Head ft	Speed r/min	Power (kw)		Motor (hp)	Efficiency %	Impeller Diam. inch	(NPSH) r ft
	m ³ /h	gpm			Shaft	Motor				
EAZS80/32-30004	72.4	5.31	171.1	1750	17.72	22	30	58	13.0	4.92
	120.7	8.86	159.6		23.17	30	40	69		5.91
	144.8	10.63	149.6		25.32	30	40	71		6.56

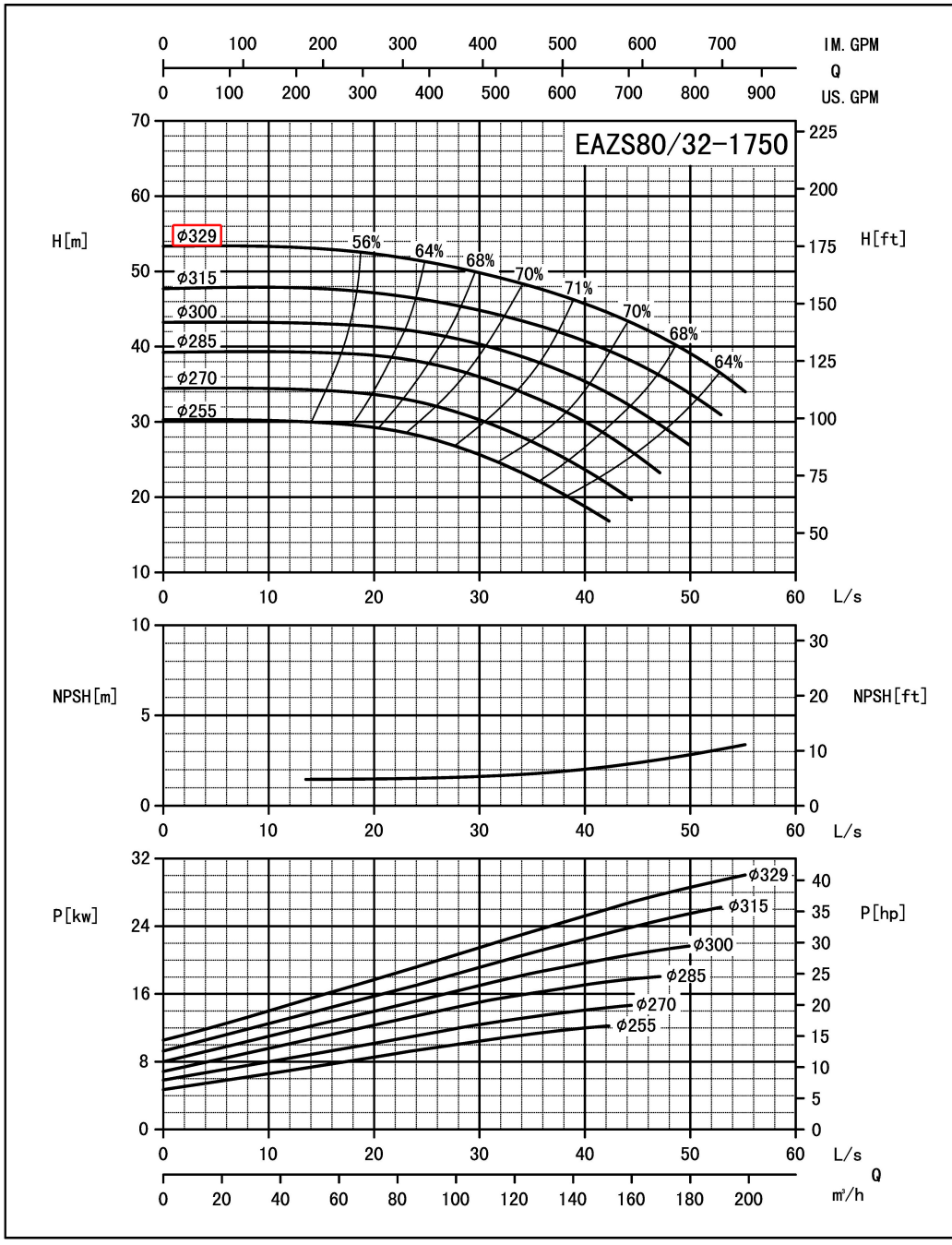

Performance to ISO9906 Grade 2 for clean cold water only

EF-A02/1406

Project	Project ID	Created by	Created on	Last update
---------	------------	------------	------------	-------------