



Technical Data

Centrifugal Pump - GCV-232

Revision no.

Page:
1

Receiver

From

Company name
Respons. Department
Person in charge
Phone number
Fax no
E-mail address



Brand: Gol Pumps
Model: GCV-232

Weight (lb)

66.1

Dimensions:

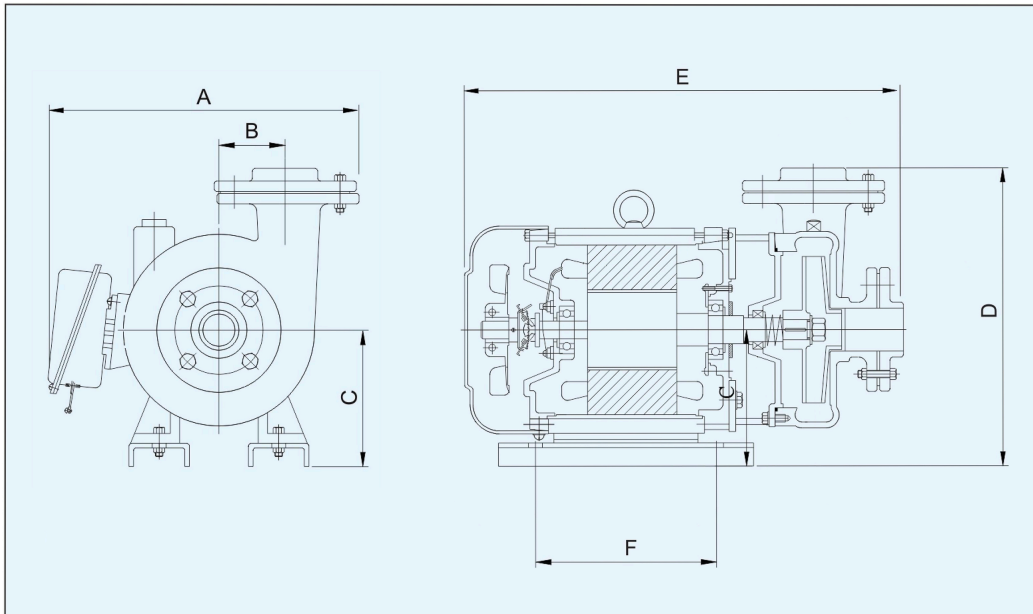

Flange (inch)	
Inlet	Outlet
2	2

Pump Installation Size (inch)					
A	B	C	D	E	F
12.7	4.3	4.7	11.3	16.4	7.9

Project

Project ID

Created by

Created on

Last update



Performance Curves

Centrifugal Pump - GCV-232

Revision no.

Page:
2

Receiver

From

Company name
Respons. Department
Person in charge
Phone number
Fax no
E-mail address

Model	Voltage	Poles	Phase	Power		Discharge Diam.	Max. Head	Max. Flow	
	v	p	ph	hp	kw	in	ft	m ³ /min	gpm
GCV-232	220-480	2	3	2	1.5	2	78.7	0.3	79.3

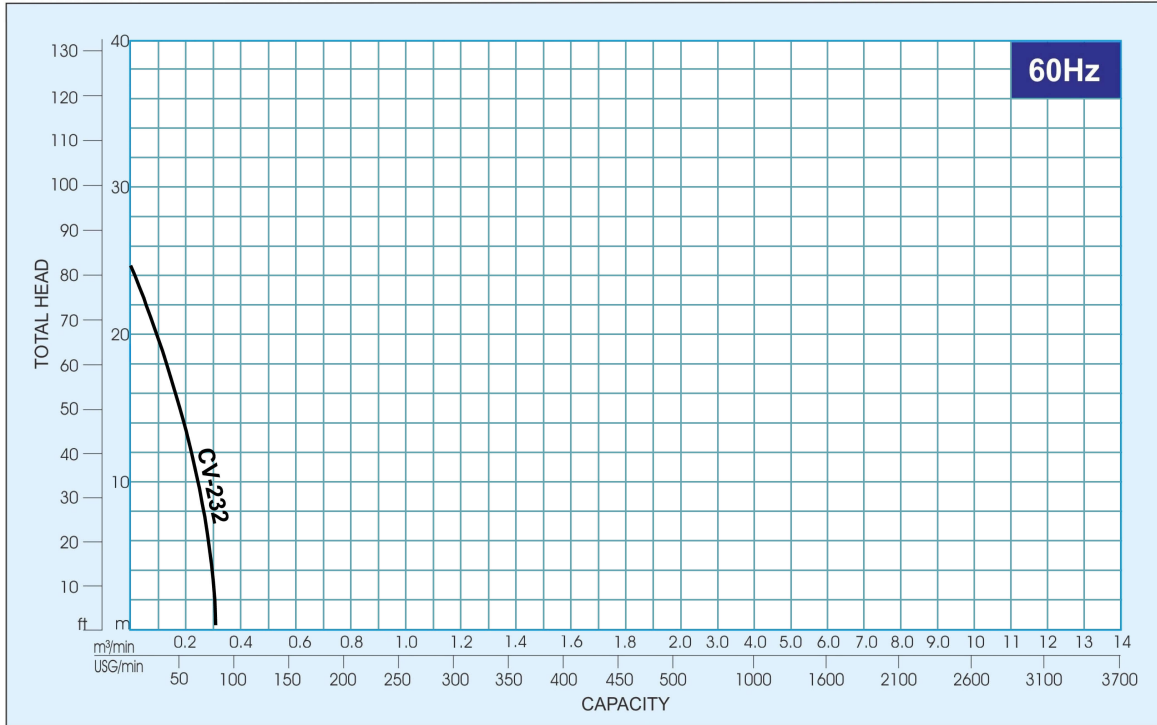

Parts List:

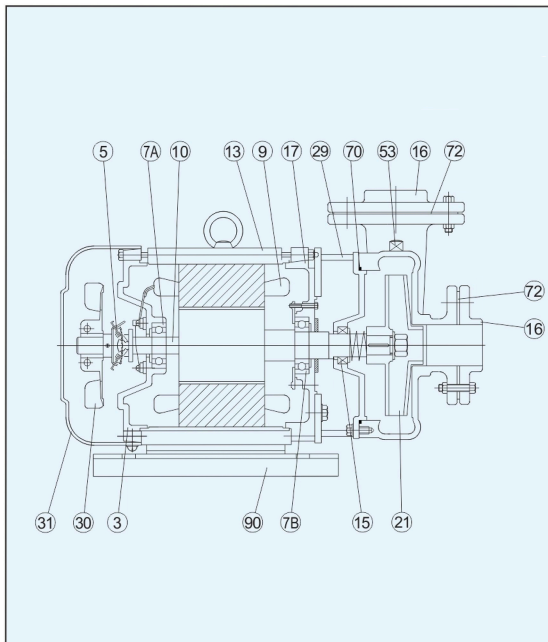

NO.	PARTS LIST	MATERIAL
3	Motor Head Cover	Cast iron
5	Centrifugal Switch	
7A	Bearing (Upper)	
7B	Bearing (Lower)	
9	Coil	
10	Shaft	SUS 304
13	Motor Casing	Cast iron
15	Mechanical Seal	Ceramic+Carbon
16	Flange Setter	Cast iron
17	Motor Lower Cover	Cast iron
21	Impeller	Bronze
29	Pump Bracket	Cast iron
30	Cooling Fan	Plastic
31	Fan Cover	Steel
53	Plug	FCD
70	O-ring	NBR
72	Outlet Rubber	Rubber
90	Support	Plastic & Steel

Project	Project ID	Created by	Created on	Last update
---------	------------	------------	------------	-------------