



Technical Data

Submersible Pump - ST 35-34

Revision no.

Page:
1

Receiver

From

Company name
Respons. Department
Person in charge
Phone number
Fax no
E-mail address



Brand: Gol Pumps
Model: ST 35-34

Weight (lb)		
Pump	Motor	Pump + Motor
27.7	64	91.7

Cable	
Length (Ft)	AWG
8.2	14

Dimensions:



Outlet	Motor Dia.	Dimensions (inch)			
		A	B	C	D
NPT 2"	4"	52.2"	2"	3.9"	79.9"

Project

Project ID

Created by

Created on

Last update



Performance Curves

Submersible Pump - SP 35-34

Revision no.

Page:
2

Receiver

From

Company name
Respons. Department
Person in charge
Phone number
Fax no
E-mail address

Pump Model	Motor		Q Capacity 3500RPM										
	kW	HP	Gal/Min	0	15.9	18.5	21.2	23.8	26.4	31.7	37	42.3	47.6
ST 35-34	5.5	7.5	Head in Feet	1011	862.9	836.6	807.1	774.3	836.6	656.2	547.9	400.3	226.4

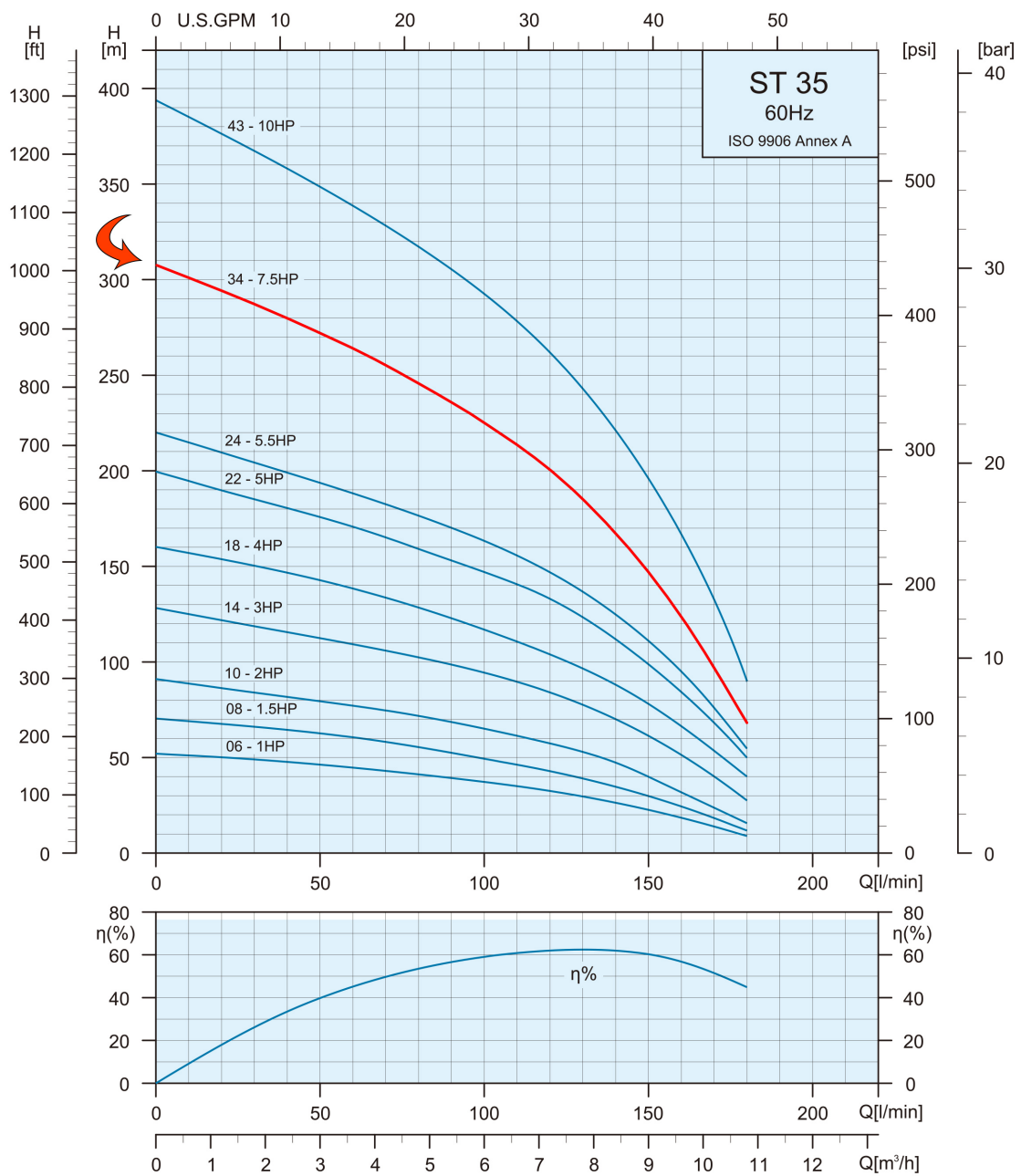

Project	Project ID	Created by	Created on	Last update
---------	------------	------------	------------	-------------



Part List and Materials

Submersible Pump - SP 35-34

Revision no.

Page:
3

Receiver

From

Company name
Respons. Department
Person in charge
Phone number
Fax no
E-mail address

Motor Model	P2		S.F	Voltage	Phase	In	I _{max}	I _{start}	PF (%)		Efficiency (%)		RPM	Thrust
	kW	HP		V	PH	A	A	A	Allowable Load	Overload Factor	Allowable Load	Overload Factor		N
	4CF6996	5.5		7.5	1.15	230	Three	24.7	26.9	126.2	0.73	0.77		77.4

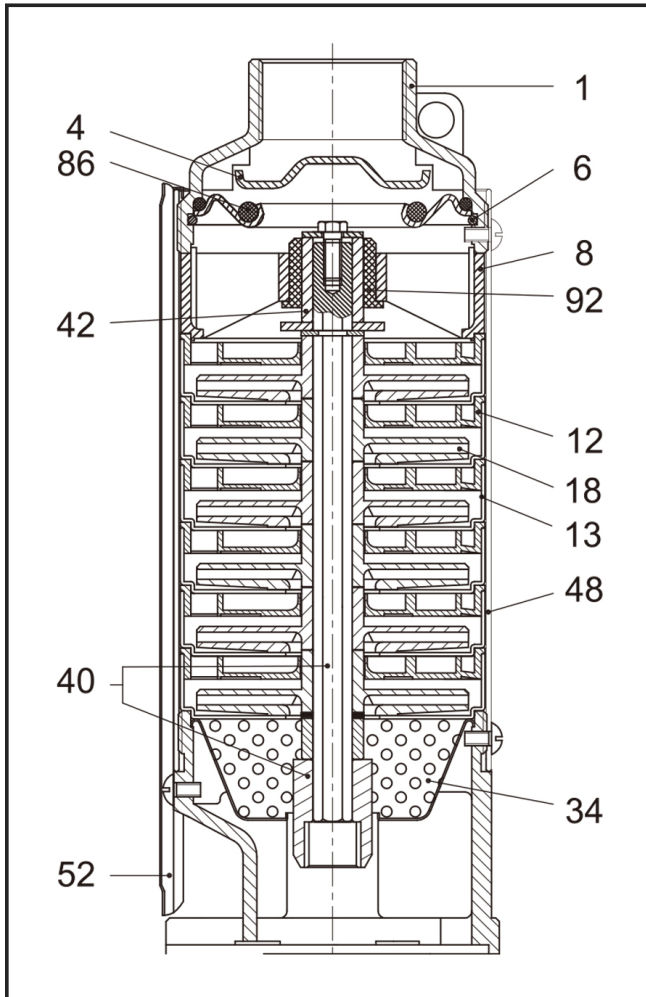

No.	Part Name	Materials
1	Discharge Head	AISI 304
4	Check Valve Cone	AISI 304
6	Check Valve Retaining Ring	AISI 304
8	Bearing Spider	Glass Filled Polycarbonate
12	Diffuser	Glass Filled Polycarbonate
13	Bowl	AISI 304
18	Impeller	Noryl
34	Strainer	AISI 304
40	Pump Shaft / Coupling	AISI 304
42	Shaft Sleeve	AISI 304 or Norly
48	Pump Casing	AISI 304
52	Cable Guard	AISI 304
86	O-Ring	NBR
92	Bearing	Polyacetal

Project

Project ID

Created by

Created on

Last update